

SPECIFICATIONS

- Order number : L1P250B
- Substrate : N-BK7
- Design wavelength : 587.6nm
- Focal length (EFL) : 250.0mm ±1%
- Back focal length (BFL) : 248.28mm
- Chamfer : Protective bevel as needed
- Grind Surface :  Mark

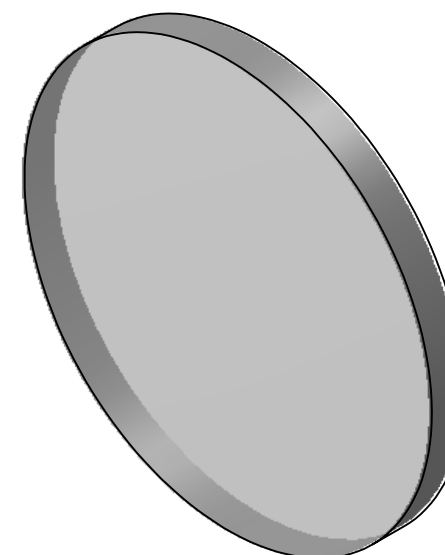

	S1	S2
Radius	CX 128.77	Infinity
Power	3.00 Ring	-
Irregularity	λ/4@633nm	λ/4@633nm
Centering	< 1 arcmin	
Surface Quality	40-20 Scratch-Dig	
Clear Aperture	90%	

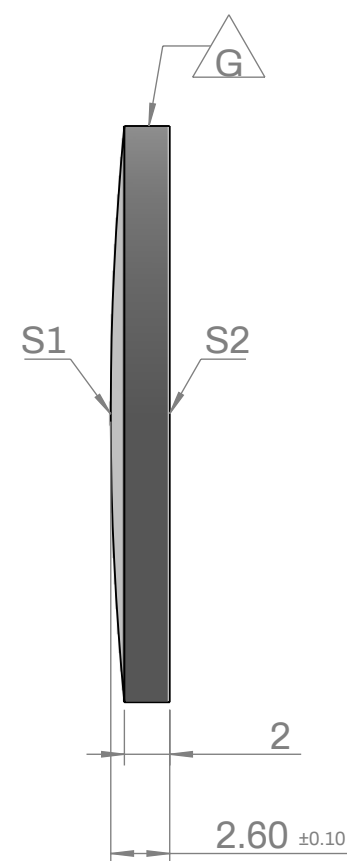
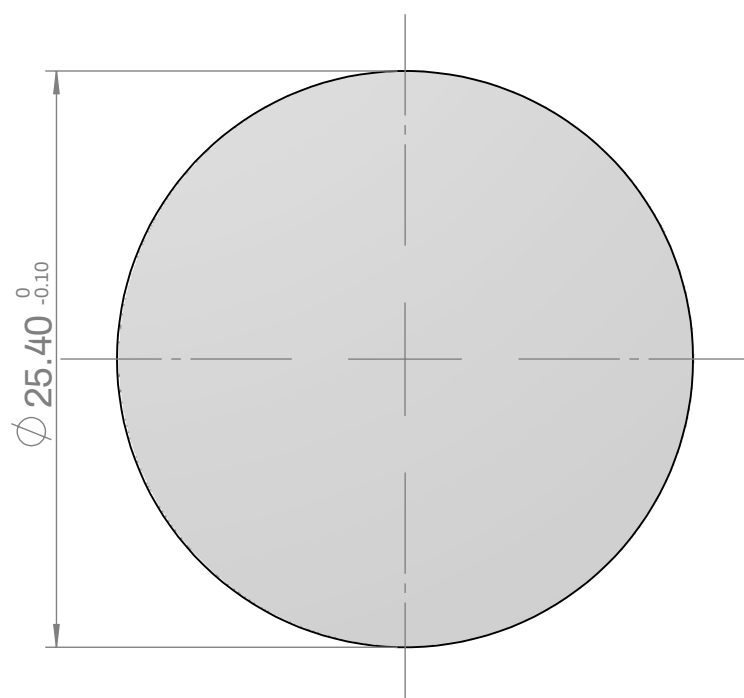

DATE	SCALE	TITLE
2023-11-03	1:1	25.4mmØ, FL= 250.0mm, N-BK7, Plano-convex Lens
3RD ANGLE PROJECTION	UNIT	ORDER NO
	MM	L1P250B