

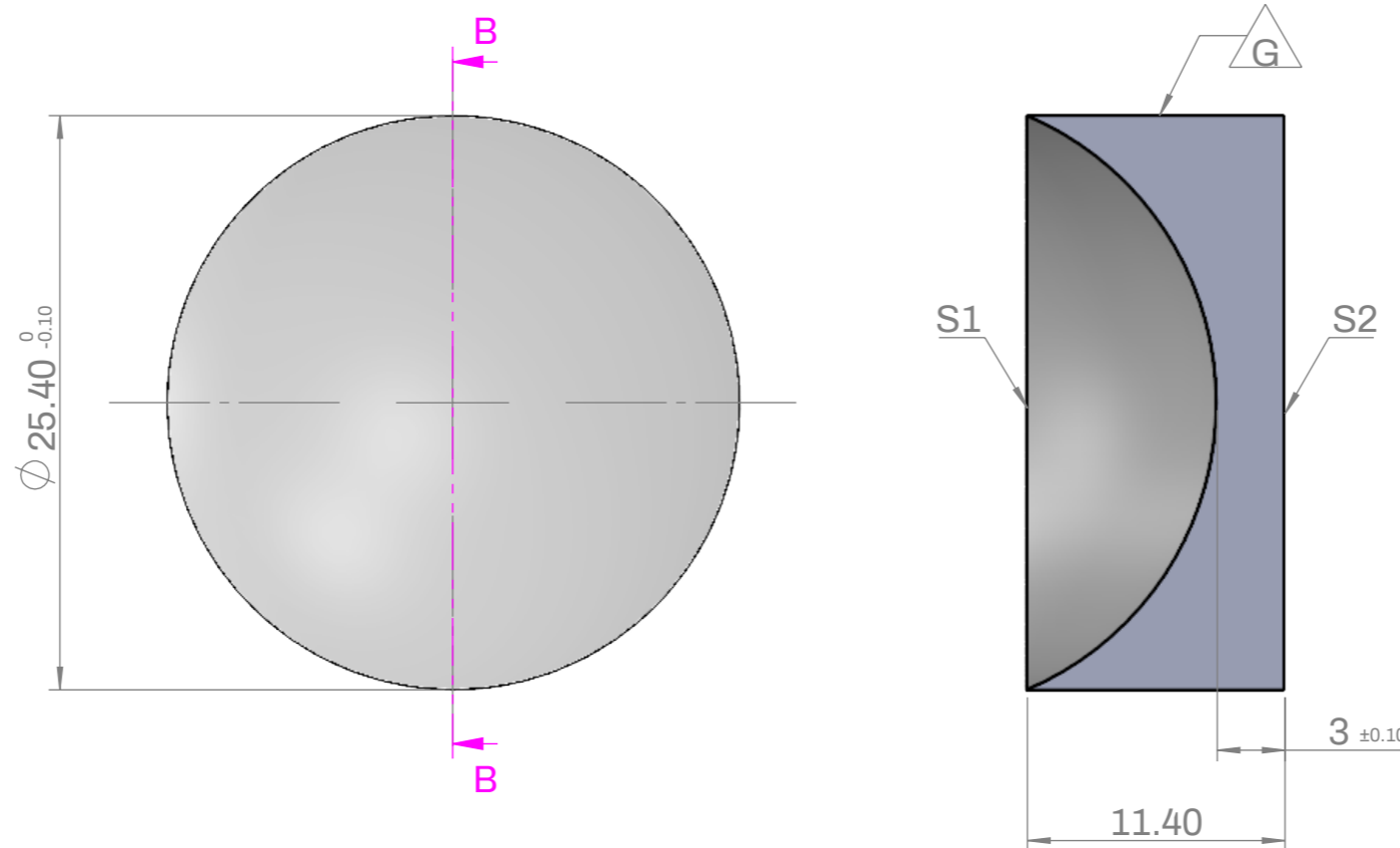

SPECIFICATIONS

- Order number : L1N30U
- Substrate : UV Fused silica
- Design wavelength : 587.6nm
- Focal length (EFL) : -30.0mm ±1%
- Back focal length (BFL) : -32.06mm
- Bevel : Protective bevel as needed
- Grind Surface :  Mark

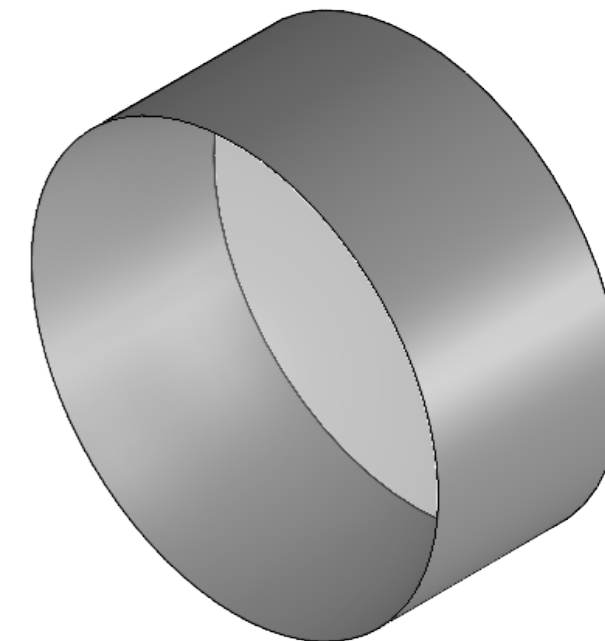

	S1	S2
Radius	CC 13.75	Infinity
Power	3.00 Ring	-
Irregularity	$\lambda/4@633\text{nm}$	$\lambda/4@633\text{nm}$
Centering	< 1 arcmin	
Surface Quality	40-20 Scratch-Dig	
Clear Aperture	90%	



DATE	SCALE	TITLE
2023-11-03	1:1	25.4mmØ, FL= -30.0mm, UVFS, Plano-concave Lens
3RD ANGLE PROJECTION	UNIT	ORDER NO
	MM	L1N30U